

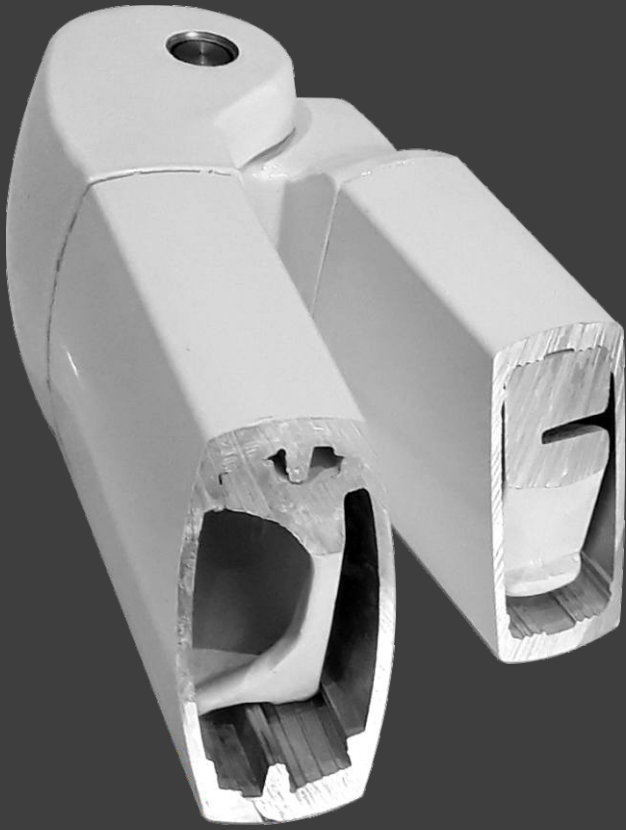

DRAGON

Terrace Awnings



From the beginning in 1992  
DRAGON company focused  
on quality and reliability of  
the products. This approach is  
strongly reflected in our designs.

DRAGON

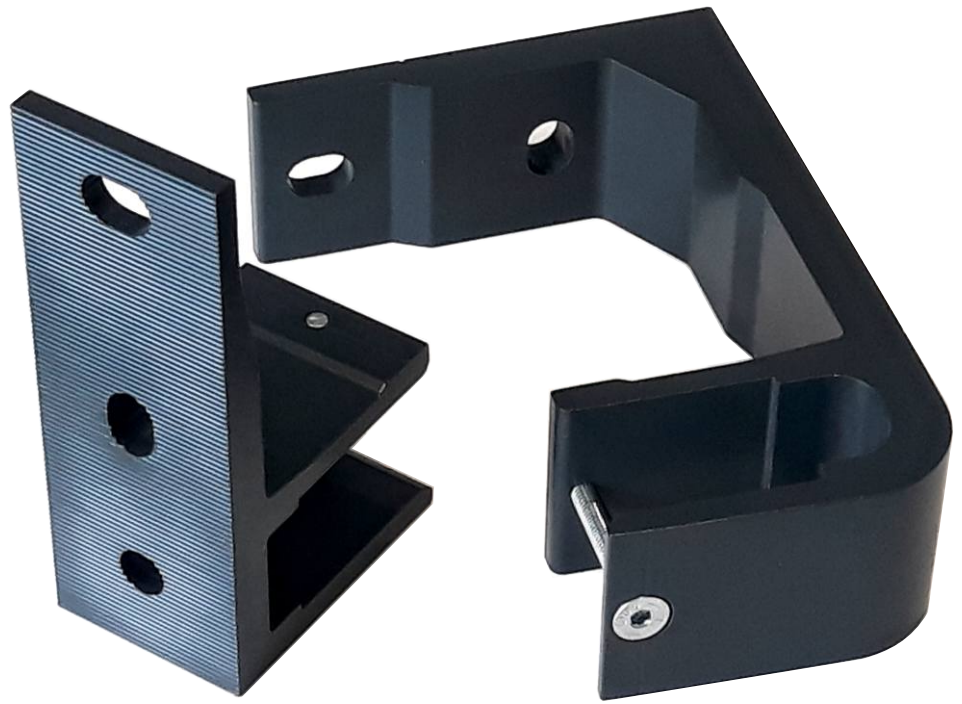

Hydro, former Sapa is a  
scandinavian aluminium producer  
where we let structural parts  
of our awnings and pergolas.



DRAGON



When choosing fabric we went for most reliable suppliers.

RECASENS  
BCN 1886

  
DICKSON®

DRAGON  
— — —

somfy®

Somfy supplies motors  
and control systems for  
our products. Industry leader  
is an obvious choice.



DRAGON

DRAGON



## Jupiter UNO

Basic classic awning  
Base production time 2 weeks



Classic (open roller tube)  
maximum size: 595x350cm



Available with:  
**Roofing** for fabric protection



Available with:  
**Alu-Volant** (tall aluminium front)



Installation brackets



Available in 6 standard colours



## Jupiter UNO

Warranty 2 years  
Wind resistance class 1

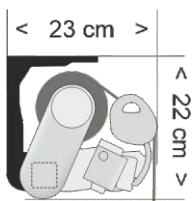
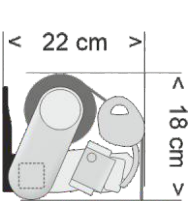

Wall / ceiling  
installation size

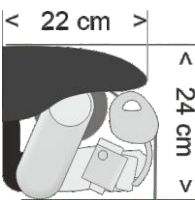

Roofing size



Alu-volant size

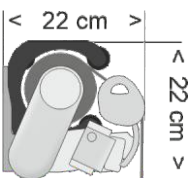

Roller tube support  
for awnings wider than 550cm

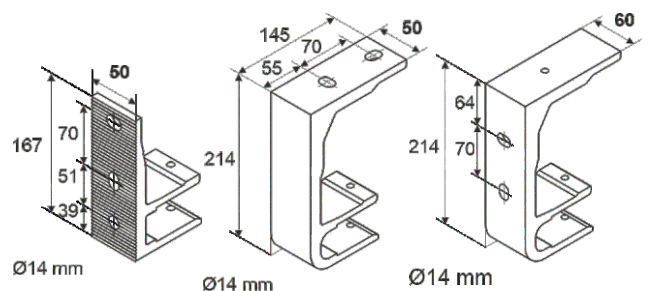

Wall / ceiling / roofing brackets

Rafter adapter

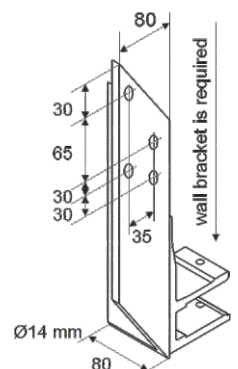

DRAGON



## Jupiter EVO

Fully featured classic awning  
Base production time 2 weeks



**Classic** (open roller tube)  
maximum size: **1200x400cm**



Available with:  
**Roofing** for fabric protection

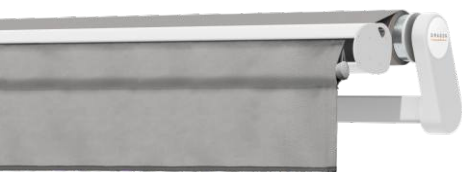

Available with:  
**Vario-Volant** (rollable valance - 130cm)  
maximum size: 700x350cm



Available with:  
**Alu-Volant** (tall aluminium front)



Installation brackets

Available in over 200 colours





# DRAGON



## Jupiter EVO

Warranty 5 years  
Wind resistance up to class 3

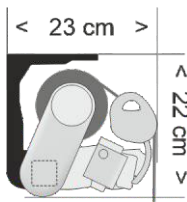
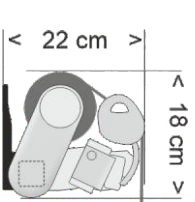

Wall / ceiling  
installtion size

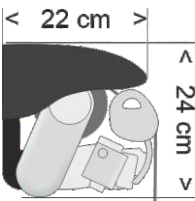

Roofing size

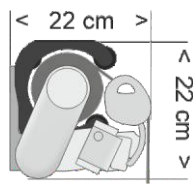

Roller tube support  
for awnings wider than 550cm

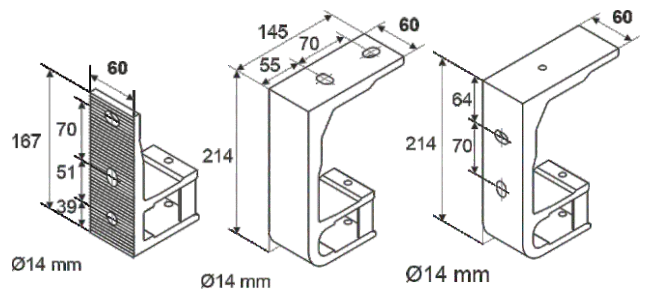

Wall / ceiling / roofing brackets

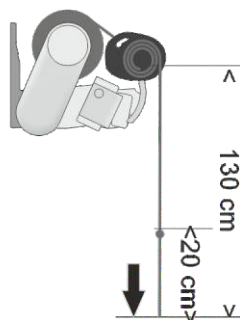
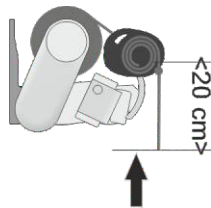
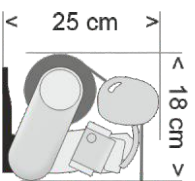

Vario-volant  
Rollable valance  
(manual/electric)



Alu-volant size

Rafter adapter

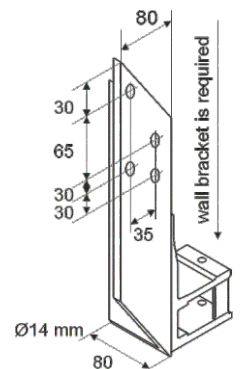

DRAGON



## Venus UNO

Basic cassette awning  
Base production time 2 weeks



Cassette Terrace Awning  
maximum size: 595x350cm

Available with:  
**Alu-Volant** (tall aluminium front)

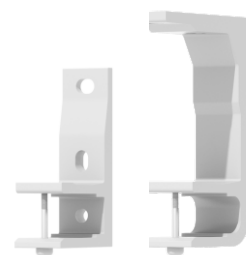

Installation brackets

Available in 6 standard colours



DRAGON



# Venus UNO

Warranty 2 years  
Wind resistance class 1

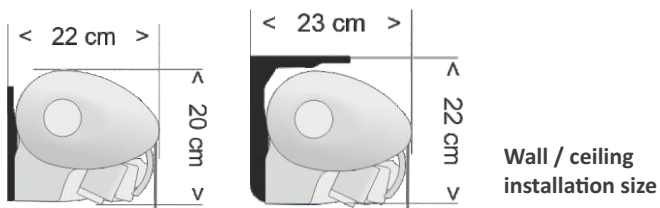

Wall / ceiling  
installation size

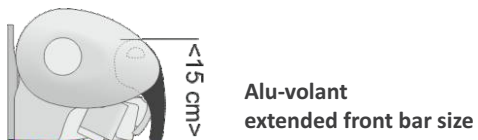

Alu-volant  
extended front bar size

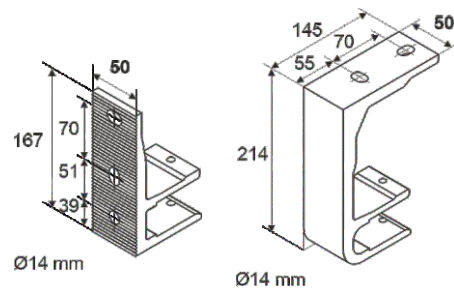

Wall / ceiling brackets

Rafter adapter

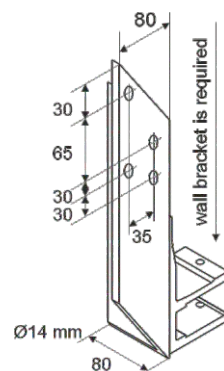

DRAGON



## Venus EVO

Fully featured cassette awning  
Base production time 2 weeks



**Cassette Terrace Awning**  
maximum size: **1200x400cm**



Available with:  
**Vario-Volant** (rollable valance - 130cm)  
maximum size: 700x350cm



Available with:  
**Alu-Volant** (tall aluminium front)



Installation brackets

Available in over 200 colours





## Venus EVO

Warranty 5 years  
Wind resistance up to class 3

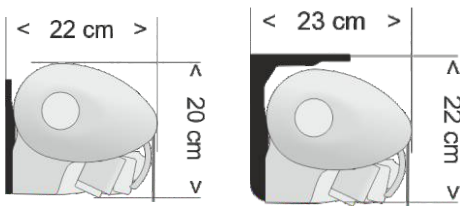

Wall / ceiling  
installtion size

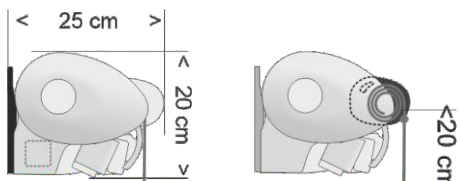

Vario-volant  
Rollable valance  
(manual/electric)

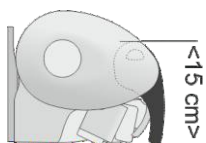

Alu-volant size

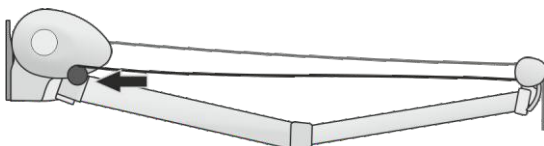
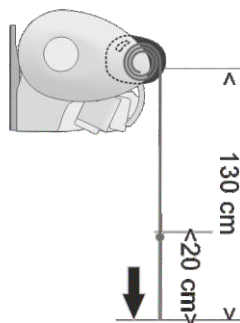

For awnings wider than 700cm  
Connection with additional roller is used

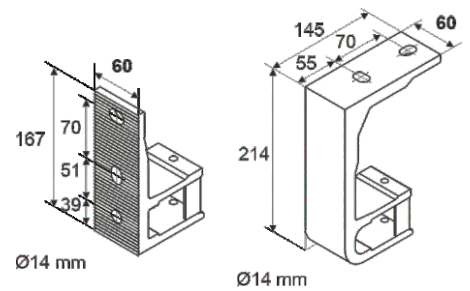

Wall / ceiling brackets

Rafter adapter

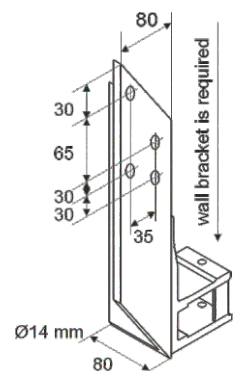

DRAGON



## Venus PRO

Minimalist design cassette awning  
Base production time 2 weeks



**Cassette Terrace Awning**  
maximum size: 1200x400cm

Available with:  
**LED lighting** (Arms, front, side caps)



Installation brackets

Available in over 200 colours





## Venus PRO

Warranty 5 years  
Wind resistance up to class 3

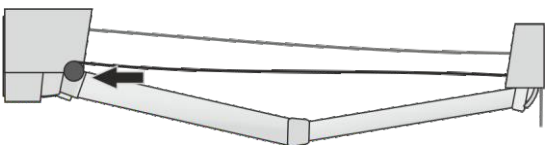
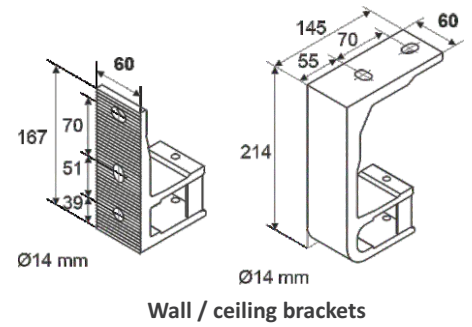
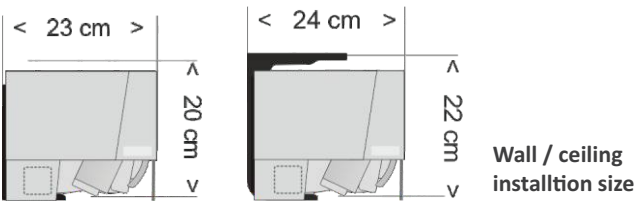

For awnins wider than 700cm  
Connection with additional roller is used

### Rafter adapter

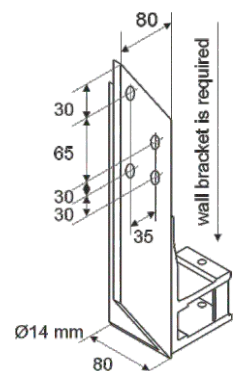

DRAGON



## Selene EVO

Full cassette awning  
Base production time 2 weeks



Full Cassette Terrace Awning  
maximum size: 1200x350cm

Available with:  
LED lighting (Arms, front)



Installation brackets

Available in over 200 colours





# DRAGON



## Selene EVO

Warranty 5 years  
Wind resistance up to class 3

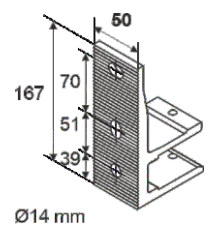
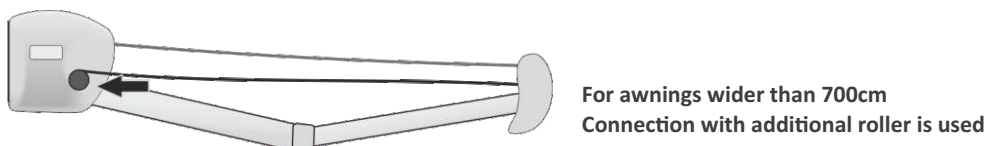
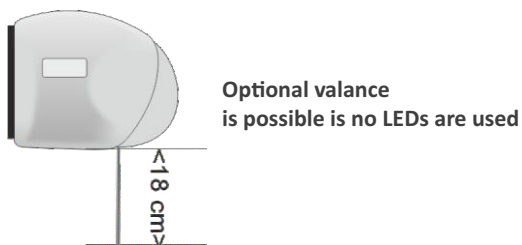
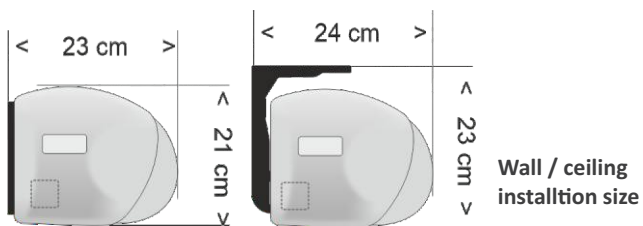

Wall brackets

Rafter adapter

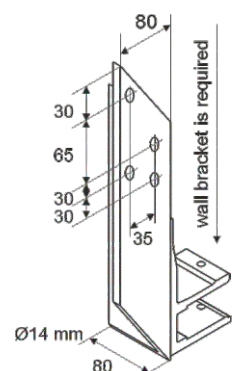

D R A G O N



## Selene PRO

Minimalist design full cassette awning  
Base production time 2 weeks



**Full Cassette Terrace Awning**  
maximum size: 1200x350cm

Available with:  
**LED lighting** (Arms, front, side caps)



Installation brackets

Available in over 200 colours





## Selene PRO

Warranty 5 years  
Wind resistance up to class 3

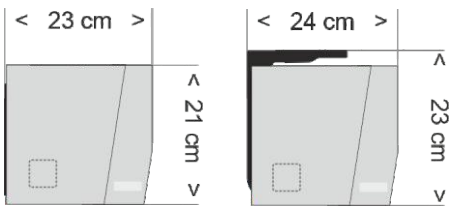

Wall / ceiling  
installtion size

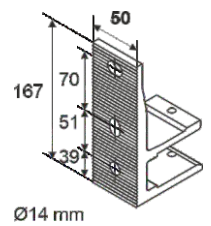

Wall brackets

Rafter adapter

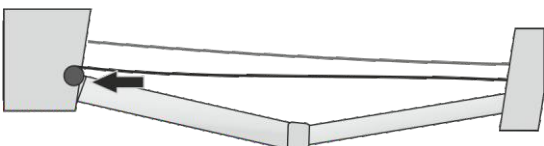
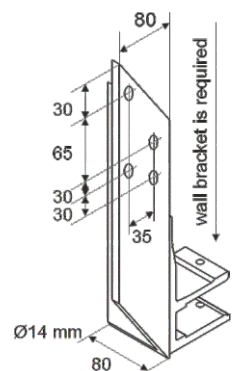

For awnings wider than 700cm  
Connection with additional roller is used